

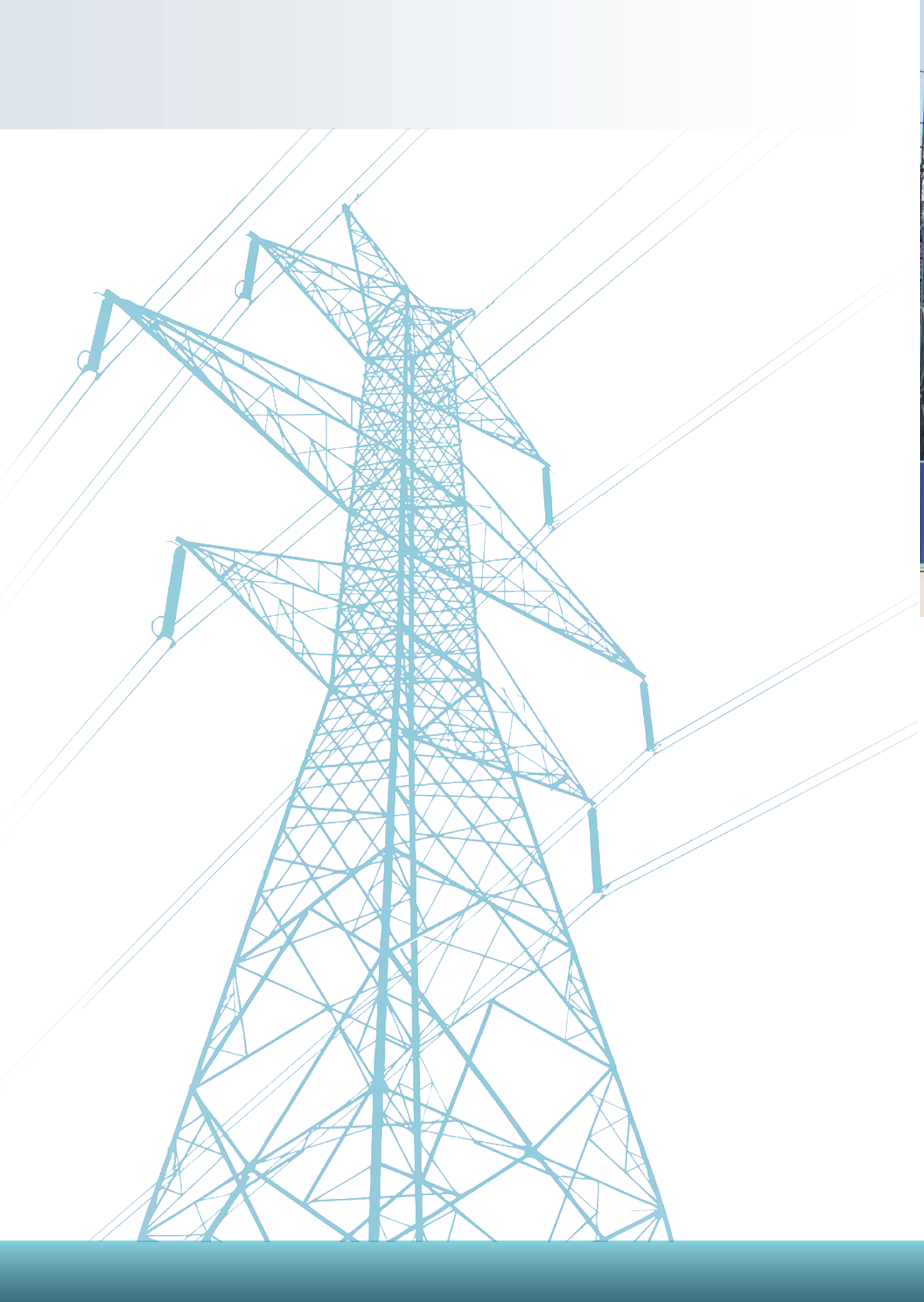

UMEK®
GLASS INSULATORS





UMEK JSC

UMEK JSC is a manufacturer of glass insulators for HV lines. UMEK, JSC is a part of a huge Russian industry group FORENERGO.

The construction of the plant began in Yuzhnouralsk (the Chelyabinsk region, Russia). The location of this plant – in the Ural district – was not chosen by coincidence: this district traces its history back to the Demidovs' plants of the 18th century. A huge industrial potential was accumulated here, that is why the first insulator was produced within 2 years in 2009 by the UMEK plant.

Nowadays the production capacity of UMEK is 4 million glass insulators per annum. The plant has got state-of-the-art equipment manufactured by leading global producers. UMEK manufactures more than 60 kinds of insulators that we supply mainly to Russia, Kazakhstan, Uzbekistan, Azerbaijan, Belarus and etc.

We focus more on the quality of produced goods and have got a privately-owned accredited testing laboratory. Moreover, we implemented the international quality management standard ISO 9001:2015. In addition to this, we care for the environment and work in accordance with ISO 14001:2015 and health and safety management system in accordance with OHSAS 18001. Our engineers continuously design new products and improve already utilised types. New developments either improve operational characteristics of the production-line product, or develop new types of insulators, for instance, with increased creepage distance and RTV-coating.



UMEK plant has celebrated its 10 years of successful work in 2017. UMEK is an active partner of the electrical power field: it takes part in local and international exhibitions holding in leading independent testing centres of Russia and Europe.

We are proud of our quality, confirmed by failure-free operation of UMEK glass insulators. Our insulators are used in service of overhead lines with voltage from 10kV to 750kV of electricity grid operating companies of the Euro-Asian region.

UMEK glass insulators are successfully operated in different climate zones, in the harsh region of Continental Arctic, providing electricity supply of oil and gas companies such as GAZPROM, PJSC, ROSNEFT, PJSC, pipelines “Eastern Siberia – Pacific Ocean” and “Power of Siberia”, in addition to this, in warm and wet climate, providing electricity supply of the Olympic objects in Sochi.

We have distinctive capabilities and unique assets with the highest technological content. Our experience and high quality of products allow us to make the best offer in the world market. We suggest long-term reliable business relation and mutually beneficial cooperation.

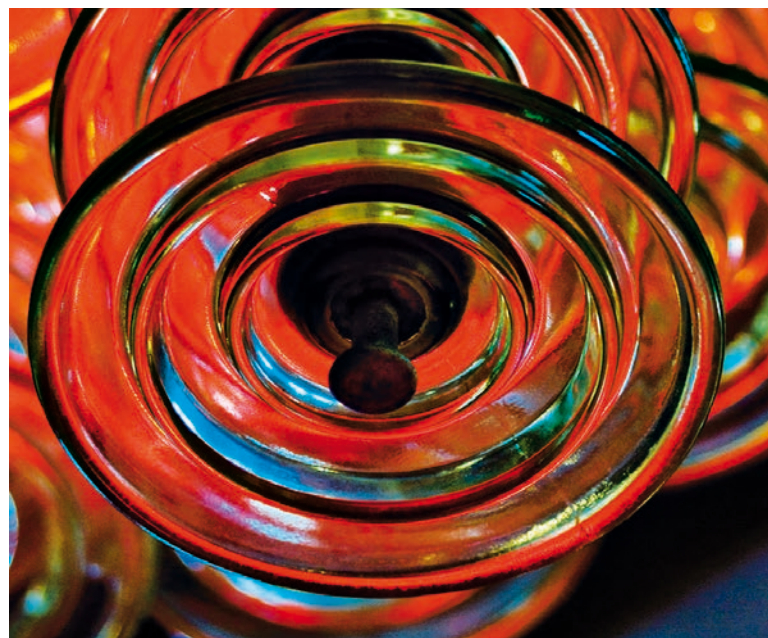

Certificates

The quality of production is the important and distinctive characteristic of any product. The improvement of production quality has got a paramount importance and allows the UMEK plant to meet the requirements and expectations of its buyers for implementation of their projects at the highest level.

UMEK pays much attention to the health of its staff and the environment. These are two interconnected things, which always have to meet certain requirements.

Besides, the workplace conditions assessment for compliance with the performance criteria required for the “Achievement Award” is carried out periodically at the enterprise according to the requirements of our customers.

Requirements imposed by our customers have allowed us to develop the most exacting approach to the organisation of production process, employees and the environment, confirmed by available certificates



ISO 9001



ISO 14001



OHSAS 18001

Insulator components

Cap and pin type suspension glass insulator consists of the following elements: insulating part (or dielectric), pin, cap and locking device.



A locking device is a part of insulator for fixation and is manufactured of stainless steel. The assembling of an insulator is performed by cement-sand mix followed by thermal wet treatment. The assembling may be performed with Portland cement or aluminosilicate cement.

A cap is for movable fixation of an insulator to another one or fittings. Caps are produced by casting from high-strength cast iron or malleable cast iron. Caps have corrosion-resistance coating, made by the method of hot-dip zinc coating. Caps for DC insulators are equipped with a collar made by casting.

The insulating part is manufactured by the compaction method from low-alkali glass followed by toughening. An insulating part might be produced in different shapes, which define the profile of insulator: standard, fog and open.

A pin of insulator is for movable fixation of an insulator to another one or fittings. Insulator's pin is produced from forged steel followed by the application of corrosion-resistant coating. Zinc is of use of corrosion-resistant coating. The method of application is hot-dip galvanizing. The pin has got a ball-shaped head for movable fixation with another insulator or fittings. Pins for DC insulators and pins for pollution and maritime area insulators are equipped with a zinc sleeve made by casting.

RTV-coating

The usage of glass insulators with RTV - coating has got many advantages:

- the RTV - coating minimises dirt retention of the insulator's surface;
- flashover characteristics are increased;
- the probability of string's flashover even under the conditions of heavy pollution reduces dramatically;
- no need to clean and wash the insulator's string, that's why operation costs of power transmission lines are considerably reduced;
- the radio interference level of insulators and strings in general decrease;
- glass insulators assume the sustainability to acts of vandalism (shooting).

The main advantage of usage of glass insulators with RTV - coating is the improvement of an index of reliability, in particular, the reducing of in-service failure rate by the electric strength and mechanical strength.



Laboratory

UMEK, JSC has got its own testing laboratory that was accredited by Rosaccreditatsia (accreditation certificate No. POC RU.0001.21AY47). This accreditation confirms the right of TL UMEK to perform tests in accordance with the Russian and international standards and complies with the criteria of Standard GOST ISO/IEC 17025-2009.

UMEK testing laboratory has got state-of-the-art equipment. Nowadays we use about 30 testing machines and more than 100 measuring devices that allow performing tests on many types of insulators: passing ceramic, rod and pin, suspension glass and porcelain, in addition to this, polymer rod and pin insulators. Testing equipment guarantees compliance with the national (GOST-R, industry standard (STO)), cross national (GOST) and international (IEC, ANSI) standards, among others, customer specifications.

Testing laboratory takes part in the round robin tests. The successful results of this confirm the quality of performed test in our laboratory, its competence and eligibility of the accreditation. TL UMEK provides routine testing at a customer's request and in presence of representatives of a customer.



We do our best to satisfy our customers! From the Arctic to the humid tropics, to the dry deserts, our glass insulators are suitable for any climate due to their high quality manufacturing. The UMEK brand has developed a reputation recognized by energy companies in Russia, Belarus, Kazakhstan, Azerbaijan, Georgia, Turkmenistan, and Kyrgyzstan. Our regular customers go beyond companies serving the power grid in these countries to include leading enterprises in the oil/gas and transportation sectors such as Gazprom, Rosneft, Surgutneftegaz, Lukoil, and Russian Railways.

Since 2012 we have been successfully reaching out to foreign markets. We have delivered to clients in Bulgaria, Serbia, Montenegro, Finland, Vietnam, and other countries.

It is our goal to satisfy customers with our products' high quality and with timely fulfillment of contract terms. We look forward to establishing long-term business relations with our clients.



Contact us:

Address: Stroiteley St., 1B, Chelyabinsk region, Russia

Tel.: (35134)4-05-33

e-mail: sales@umek.pro

website: www.umek.pro





UMEK

www.umek.pro

IEC standard



Toughened Glass Suspension Insulator

Ball and Socket

70 kN

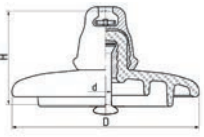
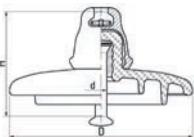
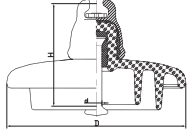
Profile	Standard			
				
Class IEC ¹	U70BS	U70BL	U70BL	
Class GOST ²	PS70E	PS70E	PS70SS	
Minimum mechanical failing load, kN	70	70	70	
Minimum mechanical residual strength, kN ³	56	56	56	
Diameter of the insulating part (D), mm	255	255	255	
Spacing, (H), mm	127	146	146	
Nominal creepage distance, mm	320	320	415	
Ball and socket coupling (d), mm ⁴	16	16	16	
Puncture voltage in insulating medium, kV ⁵	130	130	130	
Dry lightning impulse withstand voltage, kV ⁵				
a. One unit, +/- , kV	100/100	100/100	110/110	
b. Short standard string (5 units), kV	400/400	430/430	430/430	
Wet power-frequency withstand voltage, kV ⁵				
a. One unit, kV	40	40	42	
b. Short standard string (5 units), kV	185	195	195	
Radio interference ⁶	dB	60	60	60
	kV	20	20	20
	dB	86	86	86
	kV	25	25	30
Zinc coating mass, not less than, g/m ²	600	600	600	
Weight, kg	3.6	3.6	4,2	

¹ in accordance with IEC 60305 standard

² in accordance with GOST 27661

³ in accordance with IEC 60797 standard

⁴ in accordance with IEC 60120 standard

⁵ in accordance with IEC 60383-1 standard

⁶ in accordance with IEC 60437 standard

All Insulators can be provided with a zinc sleeve and with RTV coating (see pages 6,7)

Toughened Glass Suspension Insulator

Ball and Socket

70 kN

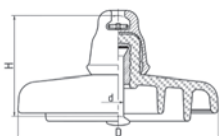
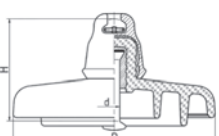
Profile	Fog type		
			
Class IEC ¹	U70BSP	U70BLP	
Class GOST ²	PSV70A	PSV70A	
Minimum mechanical failing load, kN	70	70	
Minimum mechanical residual strength, kN ³	56	56	
Diameter of the insulating part (D), mm	280	280	
Spacing, (H), mm	127	146	
Nominal creepage distance, mm	445	445	
Ball and socket coupling (d), mm ⁴	16	16	
Puncture voltage in insulating medium, kV ⁵	130	130	
Dry lightning impulse withstand voltage, kV ⁵			
a. One unit, +/- , kV	125/125	125/125	
b. Short standard string (5 units), kV	465/465	465/465	
Wet power-frequency withstand voltage, kV ⁵			
a. One unit, kV	50	50	
b. Short standard string (5 units), kV	195	195	
Radio interference ⁶	dB	60	60
	kV	20	20
	dB	86	86
	kV	30	30
Zinc coating mass, not less than, g/m ²	600	600	
Weight, kg	5.7	5.7	

¹ in accordance with IEC 60305 standard

² in accordance with GOST 27661

³ in accordance with IEC 60797 standard

⁴ in accordance with IEC 60120 standard

⁵ in accordance with IEC 60383-1 standard

⁶ in accordance with IEC 60437 standard

All Insulators can be provided with a zinc sleeve and with RTV coating (see pages 6,7)

Toughened Glass Suspension Insulator

Ball and Socket

120 kN

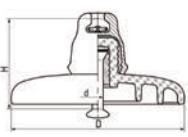
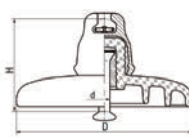
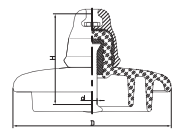
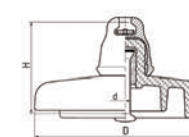
Profile	Standard			Fog type
				
Class IEC ¹	U120B	U120B	U120B	U120BP
Class GOST ²	PS120B	PS120B	PS120SS	PSV120B
Minimum mechanical failing load, kN	120	120	120	120
Minimum mechanical residual strength, kN ³	96	96	96	96
Diameter of the insulating part (D), mm	255	255	255	280
Spacing, (H), mm	146	127	146	146
Nominal creepage distance, mm	330	330	415	445
Ball and socket coupling (d), mm ⁴	16	16	16	16
Puncture voltage in insulating medium, kV ⁵	130	130	130	130
Dry lightning impulse withstand voltage, kV ⁵				
a. One unit, +/- , kV	100/100	100/100	110/110	125/125
b. Short standard string (5 units), kV	450/450	450/450	450/450	500/500
Wet power-frequency withstand voltage, kV ⁵				
a. One unit, kV	40	40	42	50
b. Short standard string (5 units), kV	195	195	195	180
Radio interference ⁶	dB	60	60	60
	kV	20	20	20
	dB	86	86	86
	kV	30	30	30
Zinc coating mass, not less than, g/m ²	600	600	600	600
Weight, kg	3.9	3.9	4,4	5.7

¹ in accordance with IEC 60305 standard

² in accordance with GOST 27661

³ in accordance with IEC 60797 standard

⁴ in accordance with IEC 60120 standard

⁵ in accordance with IEC 60383-1 standard

⁶ in accordance with IEC 60437 standard

All Insulators can be provided with a zinc sleeve and with RTV coating (see pages 6,7)

Toughened Glass Suspension Insulator

Ball and Socket

120 kN

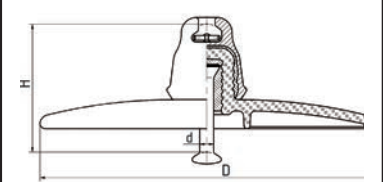
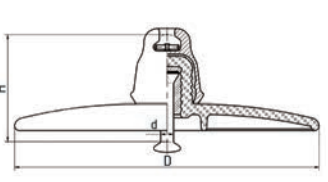
Profile	Open		
			
Class IEC ¹	—	—	
Class GOST ²	U120BA 112V	U120BA 212V	
Minimum mechanical failing load, kN	120	120	
Minimum mechanical residual strength, kN ³	96	96	
Diameter of the insulating part (D), mm	380	380	
Spacing, (H), mm	146	127	
Nominal creepage distance, mm	365	365	
Ball and socket coupling (d), mm ⁴	16	16	
Puncture voltage in insulating medium, kV ⁵	130	130	
Dry lightning impulse withstand voltage, kV ⁵			
a. One unit, +/- , kV	95/95	95/95	
b. Short standard string (5 units), kV	490/490	490/490	
Wet power-frequency withstand voltage, kV ⁵			
a. One unit, kV	50	50	
b. Short standard string (5 units), kV	205	205	
Radio interference ⁶	dB	60	60
	kV	20	20
	dB	86	86
	kV	30	30
Zinc coating mass, not less than, g/m ²	600	600	
Weight, kg	5,2	5,2	

¹ in accordance with IEC 60305 standard

² in accordance with GOST 27661

³ in accordance with IEC 60797 standard

⁴ in accordance with IEC 60120 standard

⁵ in accordance with IEC 60383-1 standard

⁶ in accordance with IEC 60437 standard

All Insulators can be provided with a zinc sleeve and with RTV coating (see pages 6,7)

Toughened Glass Suspension Insulator

Ball and Socket

160 kN

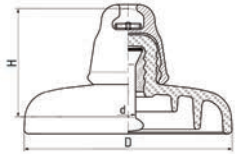
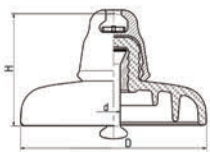
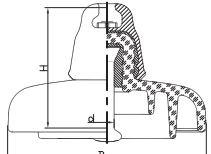
Profile	Standard		
			
Class IEC ¹	U160BS	U160BL	U160BL
Class GOST ²	PS160D	PS160D	PS160M
Minimum mechanical failing load, kN	160	160	160
Minimum mechanical residual strength, kN ³	128	128	128
Diameter of the insulating part (D), mm	280	280	280
Spacing, (H), mm	146	170	170
Nominal creepage distance, mm	385	385	470
Ball and socket coupling (d), mm ⁴	20	20	20
Puncture voltage in insulating medium, kV ⁵	130	130	130
Dry lightning impulse withstand voltage, kV ⁵			
a. One unit, +/- , kV	110/110	110/110	125/125
b. Short standard string (5 units), kV	510/510	540/540	540/540
Wet power-frequency withstand voltage, kV ⁵			
a. One unit, kV	45	45	45
b. Short standard string (5 units), kV	185	185	185
Radio interference ⁶	dB	60	60
	kV	20	20
	dB	86	86
	kV	35	40
Zinc coating mass, not less than, g/m ²	600	600	600
Weight, kg	6.2	6.2	6,8

¹ in accordance with IEC 60305 standard

² in accordance with GOST 27661

³ in accordance with IEC 60797 standard

⁴ in accordance with IEC 60120 standard

⁵ in accordance with IEC 60383-1 standard

⁶ in accordance with IEC 60437 standard

All Insulators can be provided with a zinc sleeve and with RTV coating (see pages 6,7)

Toughened Glass Suspension Insulator

Ball and Socket

160 kN

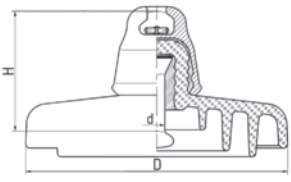
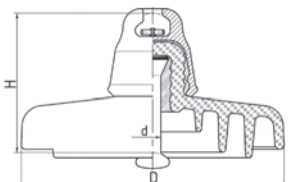
Profile	Fog type		
			
Class IEC ¹	U160BSP	U160BLP	
Class GOST ²	PSV160A	PSV160A	
Minimum mechanical failing load, kN	160	160	
Minimum mechanical residual strength, kN ³	128	128	
Diameter of the insulating part (D), mm	320	320	
Spacing, (H), mm	146	170	
Nominal creepage distance, mm	545	545	
Ball and socket coupling (d), mm ⁴	20	20	
Puncture voltage in insulating medium, kV ⁵	130	130	
Dry lightning impulse withstand voltage, kV ⁵			
a. One unit, +/- , kV	140/140	140/140	
b. Short standard string (5 units), kV	525/525	560/560	
Wet power-frequency withstand voltage, kV ⁵			
a. One unit, kV	55	55	
b. Short standard string (5 units), kV	185	230	
Radio interference ⁶	dB	60	60
	kV	20	20
	dB	86	86
	kV	35	35
Zinc coating mass, not less than, g/m ²	600	600	
Weight, kg	8.0	8.0	

¹ in accordance with IEC 60305 standard

² in accordance with GOST 27661

³ in accordance with IEC 60797 standard

⁴ in accordance with IEC 60120 standard

⁵ in accordance with IEC 60383-1 standard

⁶ in accordance with IEC 60437 standard

All Insulators can be provided with a zinc sleeve and with RTV coating (see pages 6,7)

Toughened Glass Suspension Insulator

Ball and Socket

210 kN

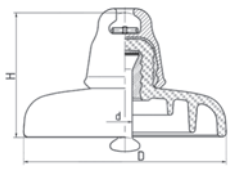
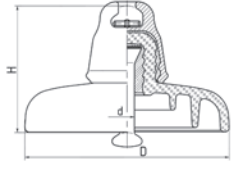
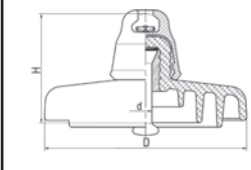
Profile	Standard		Fog type
			
Class IEC ¹	U210B	U210B	U210BP
Class GOST ²	PS210V	PS210M	PSV210D
Minimum mechanical failing load, kN	210	210	210
Minimum mechanical residual strength, kN ³	168	168	168
Diameter of the insulating part (D), mm	280	280	320
Spacing, (H), mm	170	195	170
Nominal creepage distance, mm	380	490	555
Ball and socket coupling (d), mm ⁴	20	20	20
Puncture voltage in insulating medium, kV ⁵	130	130	130
Dry lightning impulse withstand voltage, kV ⁵			
a. One unit, +/- , kV	110/110	125/125	140/140
b. Short standard string (5 units), kV	545/545	545/545	550/550
Wet power-frequency withstand voltage, kV ⁵			
a. One unit, kV	45	45	55
b. Short standard string (5 units), kV	185	185	265
Radio interference ⁶	dB	60	60
	kV	20	20
	dB	86	86
	kV	40	40
Zinc coating mass, not less than, g/m ²	600	600	600
Weight, kg	7.2	8,2	8.5

¹ in accordance with IEC 60305 standard

² in accordance with GOST 27661

³ in accordance with IEC 60797 standard

⁴ in accordance with IEC 60120 standard

⁵ in accordance with IEC 60383-1 standard

⁶ in accordance with IEC 60437 standard

All Insulators can be provided with a zinc sleeve and with RTV coating (see pages 6,7)

Toughened Glass Suspension Insulator

Ball and Socket

240 kN, 300 kN

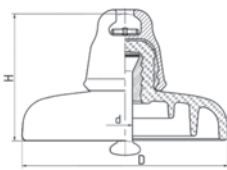
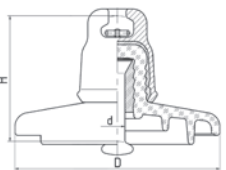
Profile	Standard		
			
Class IEC ¹	—	U300B	
Class GOST ²	PS240V	PS300V	
Minimum mechanical failing load, kN	240	300	
Minimum mechanical residual strength, kN ³	192	240	
Diameter of the insulating part (D), mm	290	320	
Spacing, (H), mm	170	195	
Nominal creepage distance, mm	380	390	
Ball and socket coupling (d), mm ⁴	24	24	
Puncture voltage in insulating medium, kV ⁵	130	130	
Dry lightning impulse withstand voltage, kV ⁵			
a. One unit, +/- , kV	110/110	130/130	
b. Short standard string (5 units), kV	545/545	530/530	
Wet power-frequency withstand voltage, kV ⁵			
a. One unit, kV	45	50	
b. Short standard string (5 units), kV	185	220	
Radio interference ⁶	dB	60	60
	kV	20	20
	dB	86	86
	kV	40	40
Zinc coating mass, not less than, g/m ²	600	600	
Weight, kg	7,1	10	

¹ in accordance with IEC 60305 standard

² in accordance with GOST 27661

³ in accordance with IEC 60797 standard

⁴ in accordance with IEC 60120 standard

⁵ in accordance with IEC 60383-1 standard

⁶ in accordance with IEC 60437 standard

All Insulators can be provided with a zinc sleeve and with RTV coating (see pages 6,7)

ANSI standard



Toughened Glass Suspension Insulator

Ball and Socket

70 kN / 120 kN / 160 kN

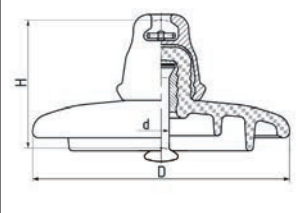
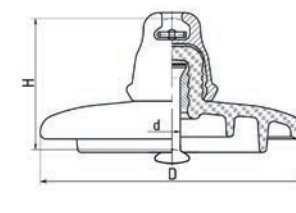
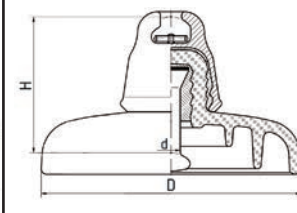
Profile			
Class ANSI ¹	52-3/52-3-H	52-5/52-5-H	52-8/52-8-H
Spacing (H) inch (mm)	5 ¾ (146)	5 ¾ (146)	5 ¾ (146)
Diameter (D) inch (mm)	10 (255)	10 (255)	11 (280)
Connecting hardware coupling ²	B&S type B	B&S type J	B&S type K
Leakage distance inch (mm)	12 5/8 (320)	13 (330)	15 1/8 (385)
Combined mechanical & electrical strength, lb (kN)	15700 (70)/20000 (89)	26900(120)/30000(133)	36000(160)/48000 (178)
Mechanical impact strength, lb x inch (N·m)	400(45)	400(45)	400(45)
Residual strength, lb (kN)	9400(42)	16100(72)	21580(96)
Tension proof, lb (kN)	7800(35)	13400(60)	17980(80)
Low-frequency dry flashover, kV ²	80	80	80
Low-frequency wet flashover, kV ²	50	50	50
Critical impulse flashover, positive, kV ²	125	125	125
Critical impulse flashover, negative, kV ²	130	130	130
Puncture voltage, kV ²	130	130	130
R.I.V. test voltage, rms to ground, kV ²	10	10	10
Maximum RIV at 1000 kHz, µV	50	50	50
Weight, lb (kg)	8,82 (4,0)	8,82 (4,0)	13,6 (6,2)

¹ in accordance with ANSI C.29.2.B standard

² in accordance with ANSI C 29.1 standard

All Insulators can be provided with a zinc sleeve and with RTV coating (see pages 6,7)

GOST standard



Toughened Glass Suspension Insulator

Ball and Socket

70 kN

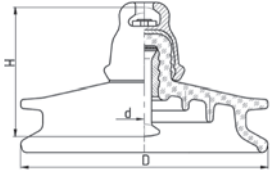
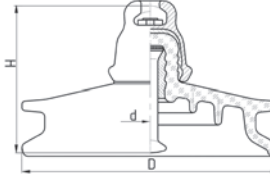
Profile			
Class GOST ¹		PSD70E	PSD70E
Minimum mechanical failing load, kN		70	70
Minimum mechanical residual strength, kN		56	56
Diameter of the insulating part (D), mm		270	270
Spacing (H), mm		127	146
Nominal creepage distance, mm		411	411
Ball and socket coupling, d (IEC 60120), mm		16	16
Puncture voltage in insulating medium, kV		130	130
50 Hz withstand voltage (dry), kV		75	75
50 Hz withstand voltage (wet), kV		45	45
Dry lightning impulse withstand voltage, 1.2/50 +/-, kV		110/110	110/110
Radio interference	dB	60	60
	kV	20	20
	dB	86	86
	kV	25	25
Weight, kg		4.6	4.6

¹ in accordance with GOST 27661

All Insulators can be provided with a zinc sleeve and with RTV coating (see pages 6,7)

Toughened Glass Suspension Insulator

Ball and Socket

100 kN

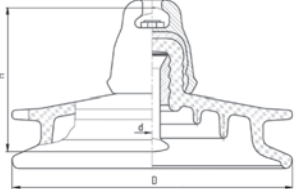
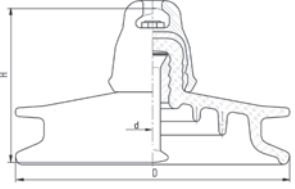
Profile			
Class GOST ¹	PSD100V	PSD100V	
Minimum mechanical failing load, kN	100	100	
Minimum mechanical residual strength, kN	80	80	
Diameter of the insulating part (D), mm	280	280	
Spacing (H), mm	127	146	
Nominal creepage distance, mm	425	425	
Ball and socket coupling, d (IEC 60120), mm	16	16	
Puncture voltage in insulating medium, kV	130	130	
50 Hz withstand voltage (dry), kV	75	75	
50 Hz withstand voltage (wet), kV	45	45	
Dry lightning impulse withstand voltage, 1.2/50 +/-, kV	100/100	100/100	
Radio interference	dB	60	60
	kV	20	20
	dB	86	86
	kV	25	25
Weight, kg	5.1	5.1	

¹ in accordance with GOST 27661

Toughened glass pin insulator ShS 10 ED

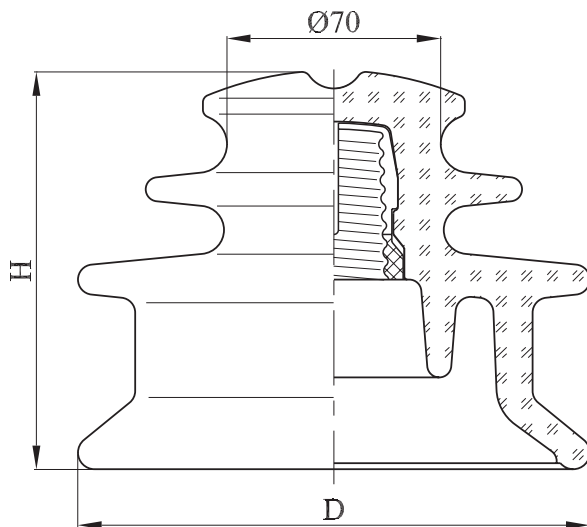

Class GOST ¹	ShS 10 ED
Nominal voltage, kV	10
Maximum working voltage, kV	12
Mechanical failing load (on bending), kN	12,5
Diameter, D, mm	170
Spacing, H, mm	132
Creepage distance, mm	340
Puncture withstand voltage (in oil), kV	130
Radio interference voltage, 34 dB, kV	7
Dry lightning impulse withstand voltage 1,2/50, kV	100
Weight, kg	2,2

¹ in accordance with GOST 1232-82

Toughened glass pin insulator ShS 20 ED

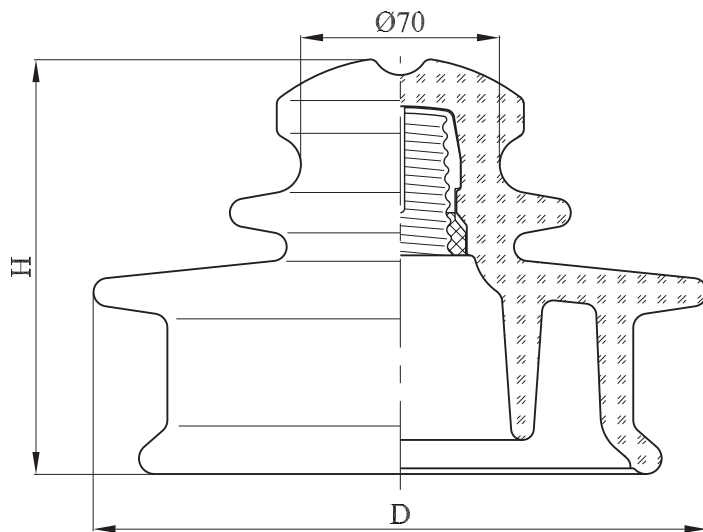

Class GOST ¹	ShS 20 ED
Nominal voltage, kV	20
Maximum working voltage, kV	24
Mechanical failing load (on bending), kN	13,0
Diameter, D, mm	216
Spacing, H, mm	146
Creepage distance, mm	420
Puncture withstand voltage (in oil), kV	140
Radio interference voltage, 34 dB, kV	13
Dry lightning impulse withstand voltage 1,2/50, kV	125
Weight, kg	3,07

¹ in accordance with GOST 1232-82

Manufacturing process

A batch mixture for glass melting consists of 7 components. All raw materials that we order, pass the incoming control, perform chemical analysis against a set of rules. Dosing and mixture of materials are made in accordance with the strict receipt. A charge-makeup area is fitted with modern automatic equipment.

A glass melting process runs in the glass furnace which overall total is 200 tons at a temperature of 1500°C. The glass furnace's output is about 35 tons per 24 hours. The level of glass mass, feed of a batch mixture to a glass furnace, temperature control are automatically regulated from a workplace.

Glass mass goes through the channel and then it is fed to a feeder, where it takes drop-shape form and supplies for the molding. The automatic 12-positional German molding machine manufactures up to 12,500 glass details per day. The product yield is 80 % or more in equivalent of U70B, which is more than 10,000 glass parts per day.

The automatic line for glass production consists of a balancing furnace, toughening machine and line of double thermal shock. 100% of glass details are subjects of positive and negative thermal shock. All glass details with inherent defects are sorted during the process of double thermal shock. Moreover, every glass detail is visually checked by a controller to identify visible defects.

The assembling of insulators is performed on the 24-position armoring conveyer with the manual and computer control. The average production capacity is 3,5 million units. The assembled insulator goes through the cycle of thermal wet treatment, after that glass insulators go through complete (100%) control by 50% tensional mechanical force, then they are completed with a locking device, marked and collected in a string, then packaged.

Inspection and control are performed at all stages of production. Raw materials, furniture, fittings, packages are subjects of the incoming control.

The chosen control points, during the production of insulating details and during the assembling of insulators, prevent passing nonconforming components to the next manufacturing stage. Insulators, before packaging, are subjects to the complete inspection and sample tests. The sampling of insulators from each batch comes to the testing laboratory for testing in accordance with the required international and national standards: IEC, ANSI, GOST.

Then insulators are packaged and film-wrapped for the protection from contamination during transportation.



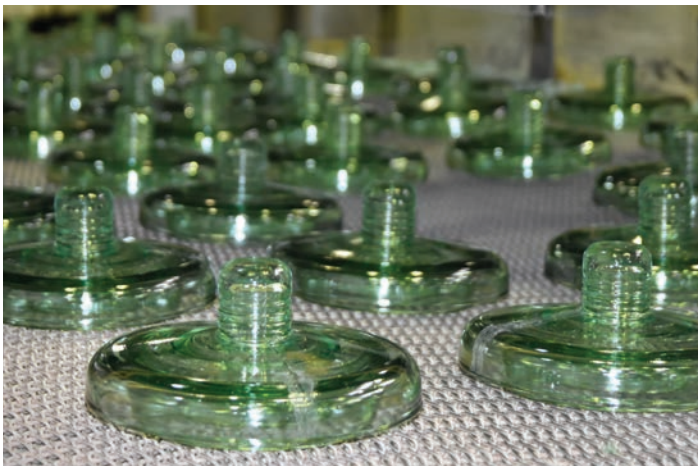
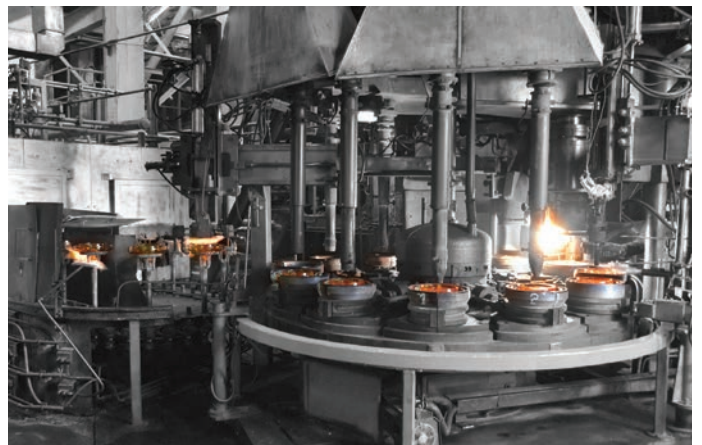
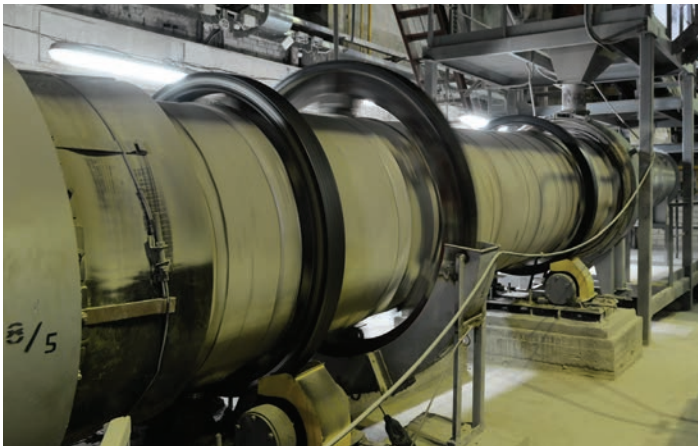

Packaging and Delivery

The plant provides freight shipping by land and by sea.

The land carriage is performed by trucks. There are 2 kinds of package – package on palette and package with crates for land carriages. Such kinds of package ensure safe delivery of different types of insulators. 20 tons of goods may be load in a truck.

We use 20” and 40” containers for sea transportation. There is a special kind of package for sea transportation – sea package, as well as a package with crates. The maximum weight of insulators for 1 container is up to 26 tons.

We use boards of soft wood for producing packages.

Dimensions of the package and the quantity of insulators on one palette are stipulated in the loading norms on page 30. The quantity of insulators on one palette may be changed depending on the total amount of the ordered insulators as well as a type of transport and a customer wishes.

Our package guarantees reliable protection of insulators from the loading to the final destination with 6 transshipments.



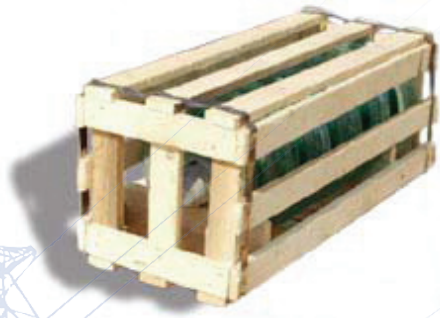

Crate (photo 1)



Sea package (photo 2)



Package with crates (photo 3)

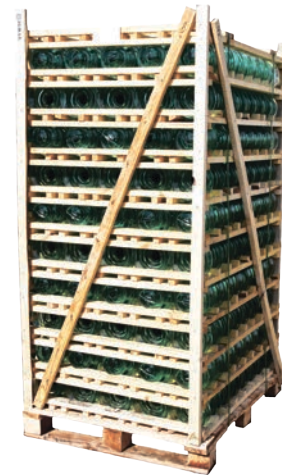

Package on pallet (photo 4)

Types of Insulators (GOST)	Types of Insulators (IEC)	Types of package	Quantity of insulators per package, pcs.	Dimensions, mm	Netto weight/ package, kg	Gross weight/ package, kg.	Weight of insulator, kg
PS70E (H=127 mm)	U70BS	Package with crates	96	1105x905x1285	345,6	447,6	3,6
			72	1105x905x1000	259,2	343,2	
		Package	200	1150x750x1800	678	741	
			175	1150x750x1600	630	681,5	
			125	1150x750x1200	423	469	
			100	1150x750x1000	338	378	
		Sea package	200	1150x720x1800	678	741	
			125	1150x720x1200	423	469	
			100	1150x720x1000	338	406	
PS70E (H=146 mm)	U70BL	Package with crates	96	1105x1005x1285	345,6	460,8	3,6
			72	1105x1005x1000	259,2	352,8	
		Package	200	1150x800x1800	720	800	
			175	1150x800x1600	630	704	
			125	1150x800x1200	450	512	
			100	1150x800x1000	360	416	
		Sea package	200	1150x800x1800	720	800	
			125	1150x800x1200	450	503	
			100	1150x800x1000	360	416	
PS70SS (H=146 mm)	U70BL	Package with crates	200	1155x840x1870	840	907	4,2
			175	1155x840x1665	735	796	
			125	1155x840x1255	525	576	
			100	1155x840x1050	420	466	
PS120B (H=127 mm)	---	Package with crates	96	1105x905x1285	374,4	476,4	3,9
			72	1105x905x1000	280,8	364,8	
		Package	200	1150x750x1800	768	831	
			175	1150x750x1600	683	734,5	
			125	1150x750x1200	482	528	
			100	1150x750x1000	386	426	
		Sea package	200	1150x720x1800	768	831	
			125	1150x720x1200	482	538,5	
			100	1150x720x1000	386	436	
PS120B (H=146 mm)	U120B	Package with crates	96	1105x1005x1285	374,4	489,6	3,9
			72	1105x1005x1000	280,8	374,4	
		Package	200	1150x800x1800	780	860	
			175	1150x800x1600	683	742,6	
			125	1150x800x1200	488	550	
			100	1150x800x1000	390	426	
		Sea package	200	1150x800x1800	780	860	
			125	1150x800x1200	488	550	
			100	1150x800x1000	390	426	

Container / Truck Load

Truck			20 foot container			40 foot container		
Quantity of packages, pcs	Quantity of insulators, pcs	Weight, kg	Quantity of packages, pcs	Quantity of insulators, pcs	Weight, kg	Quantity of packages, pcs	Quantity of insulators, pcs	Weight, kg
28	4056	19056	12	2016	9620	26	4368	20680
19			12			26		
30	5250	20445						
			32	3200	12992	64	6400	25984
26	3936	19038	10	1680	8280	22	3696	17550
20			10			22		
30	5250	20705						
			14	2800	10388	28	5600	20776
			14	3150	12080	28	6300	24130
			14			28		
42	4200	19572	12	1500	12504			
			12	1200		56	5600	26096
28	3840	19177	12	2016	10210	26	4368	22000
16			12			26		
27	4725	19831						
			14	2800	11634			
			14	3150	13643			
			14			60	6000	26160
26	3720	19095	10	1680	8790	22	3696	18630
17			10			22		
			14	2800	11650	28	5600	23296
27	4725	20050,2						
			14	3150	13520			
			14			56	5600	24330
			14	2800	11650	28	5600	23296
			14	3150	13520			
			14			56	5600	24330

Types of Insulators (GOST)	Types of Insulators (IEC)	Types of package	Quantity of insulators per package, pcs.	Dimensions, mm	Netto weight/ package, kg	Gross weight/ package, kg.	Weight of insulator, kg			
PS120B, PS120SS (H=146 mm)	U120B	Package	200	1155x840x1870	880	947	4,4			
			175	1155x840x1665	770	831				
			125	1155x840x1255	550	601				
			100	1155x840x1050	440	486				
PSD70E (H=127 mm)	---	Package with crates	96	1155x905x1310	441,6	549,8	4,6			
			72	1155x905x1015	331,2	419,2				
		Package	120	1150x740x1850	552	620				
			100	1150x740x1575	460	532				
			80	1150x740x1285	368	422				
			60	1150x740x990	276	323				
		Sea package	120	1150x720x1850	552	620				
			80	1155x725x1300	368	433				
			60	1155x725x1015	276	330				
		PSD70E (H=146 mm)	---	Package with crates	96	1155x1005x1310		441,6	537,9	4,6
72	1155x1005x1015				331,2	427,5				
Package	120			1150x810x1850	552	662				
	100			1150x810x1575	460	557				
	80			1150x810x1285	368	452				
	60			1150x810x990	276	347				
Sea package	120			1150x810x1850	552	662				
	80			1150x810x1285	368	446				
	60			1150x810x990	276	340				
PSV120B (H=127 mm)	---			Package with crates	96	1255x905x1420	547,2	660,7	5,7	
		72	1255x905x1100		410,4	503				
		Package	120	1170x700x1734	678	727				
			100	1170x700x1475	565	610				
			80	1170x700x1216	452	494				
			60	1170x700x957	342	380				
		Sea package	120	1170x700x1734	678	727				
			80	1170x700x1216	452	506				
			60	1170x700x957	342	390				
		PSV120B (H=146 mm)	U120BP	Package with crates	96	1255x1005x1420	547,2	670,5		5,7
72	1255x1005x1100				410,4	511				
Package	100			1165x705x1430	570	629				
	80			1165x705x1190	456	508				
	60			1165x705x905	342	384				
	Sea package			100	1165x705x1430	566	624			
80				1165x705x1190	456	510				
60				1165x705x905	342	390				
PS160D (H=146 mm)	U160BS			Package with crates	96	1205x1005x1380	595,2	717,2	6,2	
					72	1205x1005x1075	446,2	546		
		Package	100	1155x705x1460	620	681				
			80	1155x705x1210	496	532				
			60	1155x705x960	372	418				
			Sea package	100	1155x705x1430	613	671			
		80		1155x705x1190	496	532				
		60		1155x705x960	372	418				

Truck			20 foot container			40 foot container		
Quantity of packages, pcs	Quantity of insulators, pcs	Weight, kg	Quantity of packages, pcs	Quantity of insulators, pcs	Weight, kg	Quantity of packages, pcs	Quantity of insulators, pcs	Weight, kg
41	4100	19926						
28	2688	15395	12	2016	11730	26	4368	25300
			12			26		
32	3840	19840						
34	3400	18088						
			14	1680	8680	32		
			14	1960	10560	32	4480	24416
			14			32		
26	2496	13990	10	1680	9800	22	3696	21450
			10			22		
30	3600	19860						
32	3200	16780						
			14	1680	8722	28	3360	17444
			14	1960	11004	28	3920	21380
			14			28		
24	2304	15860						
			20	1440	10220	44	3168	22220
32	3200	19520						
			13	1820	11648	30	4080	26100
			13			28		
23	2208	15422						
			18	1296	9340	36	2592	18540
32	3200	20181						
			16	1600	9984			
			16	2240	14340	30	4080	26220
			16			28		
26	2496	18650						
			20	1440	11000	40	2880	22000
30	3000	20430						
			16	1600	10736	34	3400	22814
			16	2240	15500		3720	26048
			16			62		

Types of Insulators (GOST)	Types of Insulators (IEC)	Types of package	Quantity of insulators per package, pcs.	Dimensions, mm	Netto weight/ package, kg	Gross weight/ package, kg.	Weight of insulator, kg
PS160D (H=170 mm)	U160BL	Package with crates	96	1205x1155x1380	595,2	726,6	6,2
			72	1205x1155x1075	446,4	553,8	
		Package	100	1165x775x1430	620	682	
			80	1165x775x1190	496	551	
			60	1165x775x905	372	421	
		Sea package	100	1165x775x1430	620	682	
			80	1165x775x1190	496	551	
			60	1165x775x905	372	421	
		PS160M (H=170 mm)	U160BL	Package	100	1155x795x1470	
80	1155x795x1220				568	619,5	
PSV160A (H=146 mm)	U160BSP	Package with crates	54	1025x1005x1195	448,2	529,3	8,0
			Package	96	1050x710x1950	768	
		80		1050x710x1650	640	698	
		64		1050x710x1365	512	564	
		Sea package	80	1050x710x1650	640	704	
			48	1050x710x1075	480	434	
PSV160A (H=170 mm)	U160BLP	Package with crates	54	1025x1155x1195	432	517,8	8,0
			Package	100	1050x955x1650	800	
		80		1050x795x1650	640	700	
		60		1050x955x1075	480	535	
		Sea package	100	1050x955x1650	800	868	
			60	1050x955x1075	480	535	
80	1050x795x1065		640	700			
PS210V (H=170 mm)	U210B	Package with crates	96	1255x1155x1420	691,2	823,2	7,2
			72	1255x1155x1105	518,4	626,4	
		Package	100	1165x775x1560	720	781	
			80	1165x775x1290	576	631	
			60	1165x775x990	432	481	
		Sea package	100	1155x790x1520	720	784	
80	1155x790x1260		576	633			
60	1155x790x1000		432	482			
PS210M (H=170 mm)	U210B	Package	100	1155x810x1470	816	874	8,16
			80	1155x810x1220	652,8	704,8	
PSV210D (H=170 mm)	U210BP	Package with crates	54	1025x1155x1195	459	544,8	8,5
			Package	100	1050x955x1650	850	
		80		1050x795x1650	680	740	
		60		1050x955x1075	510	565	
		Sea package	80	1050x710x1650	670	700	
48	1050x710x1075		510	565			
PS300V (H=195 mm)	U300B	Package	60	1070x700x1660	600	655,6	10
			36	1070x700x1080	360	404,4	
		Sea package	60	1070x700x1660	600	655,6	
			36	1070x700x1080	360	404,4	
			125	1150x750x1200	482	528	
100	1150x750x1000	386	426				

Truck			20 foot container			40 foot container		
Quantity of packages, pcs	Quantity of insulators, pcs	Weight, kg	Quantity of packages, pcs	Quantity of insulators, pcs	Weight, kg	Quantity of packages, pcs	Quantity of insulators, pcs	Weight, kg
22	2112	15990						
			16	1152	8860	36	2592	19900
29	2900	19778	14	1400	9436			
			14	1960	13700			
			14					
			14	1400	9436	30	3000	20460
			14	1960	13700			
			14					
26	2600	19955				60	3600	25360
26	1404	13765	20	1080	10700	44	2376	23430
28	2240	19544						
						18	2784	24824
						28		
26	1404	13465	20	1080	10500	44	2376	22900
23	2300	19780						
28	2240	19600						
			12	1200	10416	8	2720	24170
			24	1440	12870	32		
						28		
20	1920	16465						
			16	1152	10150	36	2592	22700
25	2500	20125	14	1400	10934	30	3000	23430
			14	1960	14840			
			14					
			14	1400	10976	30	3000	23430
			14	1960	15610			
			14					
						55	3300	26510
23	2300	20102						
26	1404	14165	20	1080	11000	44	2376	24100
23	2300	20930						
27	2160	19980						
						28	2240	22336
			24	1440	13590			
30	1800	19530				16	2256	25050
			32	1152	13000	36		
						16	2256	25050
			32	1152	13000	36		
			14	3150	13450			
			14					
						60	6000	25700

Types of Insulators (GOST)	Types of Insulators (IEC)	Types of package	Quantity of insulators per package, pcs.	Dimensions, mm	Netto weight/ package, kg	Gross weight/ package, kg.	Weight of insulator, kg
PSV70A (H=127 mm)	U70BSP	Package with crates	96	1255x905x1420	547,2	660,7	5,7
			72	1255x905x1100	410,4	503	
		Package	120	1170x700x1734	678	727	
			100	1170x700x1475	565	610	
			80	1170x700x1216	452	494	
			60	1170x700x957	342	380	
		Sea package	80	1170x700x1216	452	494	
			60	1170x700x957	342	380	
PSV70A (H=146 mm)	U70BLP	Package with crates	96	1255x1005x1420	547,2	670,5	5,7
			72	1255x1005x1100	410,4	511	
		Package	100	1165x705x1430	570	651	
			80	1165x705x1190	456	508	
			60	1165x705x905	342	384	
			Sea package	80	1165x705x1190	456	
		60		1165x705x905	342	384	
		PS240V (H=170 mm)	---	Package	100	1165x775x1560	
80	1165x775x1290				632	687	
60	1165x775x990				474	523	
Sea package	100			1165x775x1560	790	851	
	80			1165x775x1290	632	687	
	60			1165x775x990	474	523	
PSD100V (H=127 mm)	---	Package	100	1175x740x1705	510	592	5,1
			60	1175x740x1105	306	367	
		Sea package	100	1175x740x1705	510	592	
PSD100V (H=146 mm)	---	Package	100	1175x810x1705	510	597	5,1
			60	1175x810x1105	306	371	
		Sea package	100	1175x810x1705	510	597	
U120BA (H=127 mm)	---	Package with crates	42	970x810x1370	218,4	286	5,2
			28	970x810x965	145,6	198,6	
U120BA (H=146 mm)	---	Package with crates	42	1085x810x1370	218,4	292,8	5,2
			28	1085x810x965	145,6	203,8	
ShS 10 ED	---	Package	440	1140x970x2160	968	1146	2,2
			400	1140x970x1980	880	1046	
			320	1140x970x1630	704	846	
ShS 20 ED	---	Package	270	1085x960x2027	810	969	3,07

Truck			20 foot container			40 foot container		
Quantity of packages, pcs	Quantity of insulators, pcs	Weight, kg	Quantity of packages, pcs	Quantity of insulators, pcs	Weight, kg	Quantity of packages, pcs	Quantity of insulators, pcs	Weight, kg
24	2304	15860						
			20	1440	10220	44	3168	22220
32	3200	19840						
			16	2240	14000			
			16			68	4080	25870
			16	2240	14000			
			16			68	4080	25870
23	2208	15422						
			18	1296	9340	36	2592	18540
32	3200	19968	16	1600	9984	34	3400	21216
			16	2240	14340			
			16			61	3660	23800
			16	2240	14340			
			16			61	3660	23800
22	2200	18722						
			14	1960	17050	30	3000	25630
			14					
						30	3000	25630
			14	1960	17050			
			14					
32	3200	18945	11	1100	6650	26	2600	15470
			11	1100	6650	26	2600	15470
32	3200	19104	11	1100	6740	24	2400	14480
			11	1100	6740	24	2400	14480
41	2870	19868,6						
41								
36	2520	17877,6						
36						56	1568	11424
19	7600	19351,5	12	4800	12580	24	9600	25200
22	7040	18612	12	3840	10180	24	7680	20320
20	5400	19380						

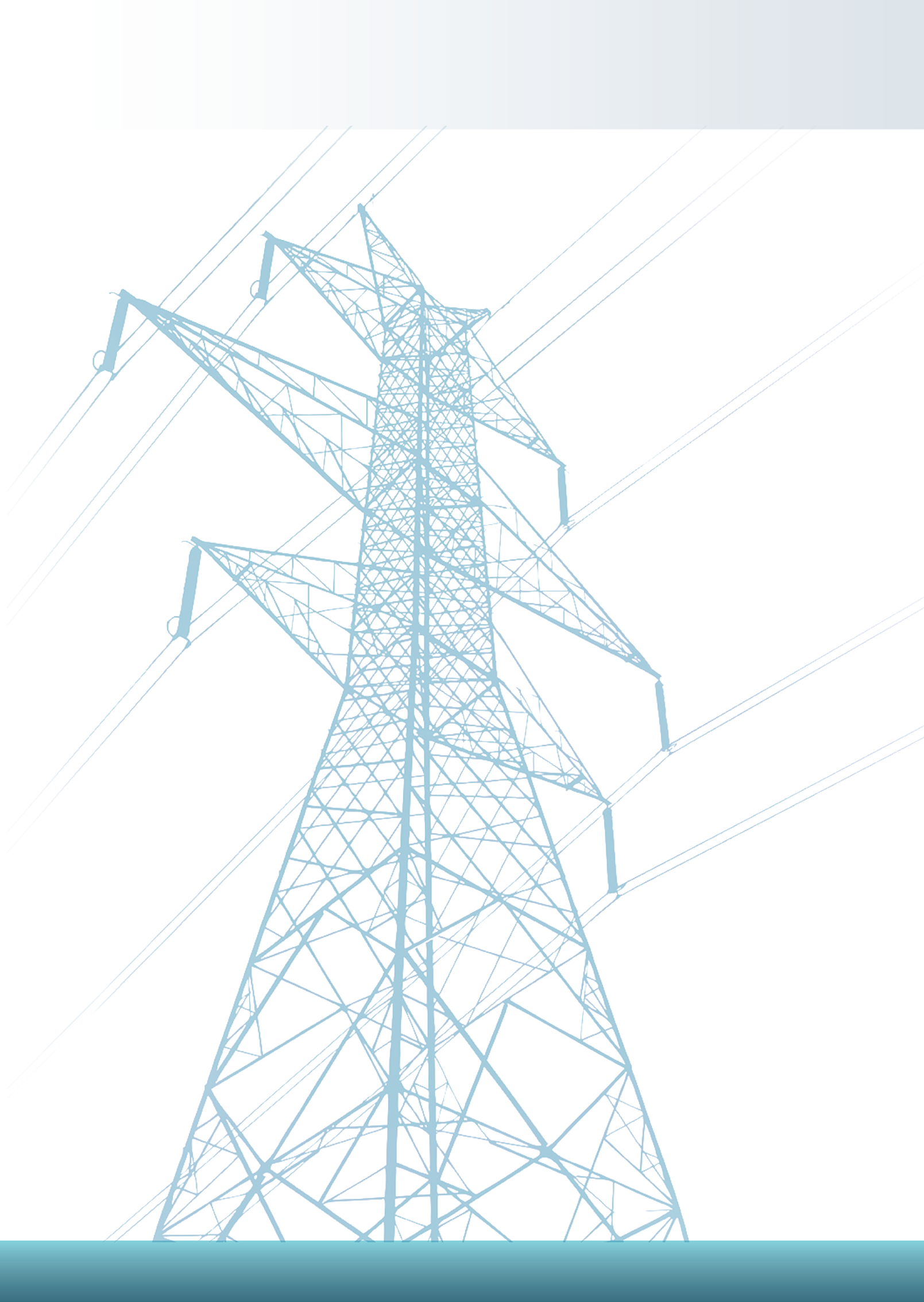

«UMEK», STROITELEY 1B, YUZHNOURALSK, 457040 RUSSIA
TEL: 7 (351) 344-05-33
SALES@UMEK.PRO
WWW.UMEK.PRO